

Technical Handbook

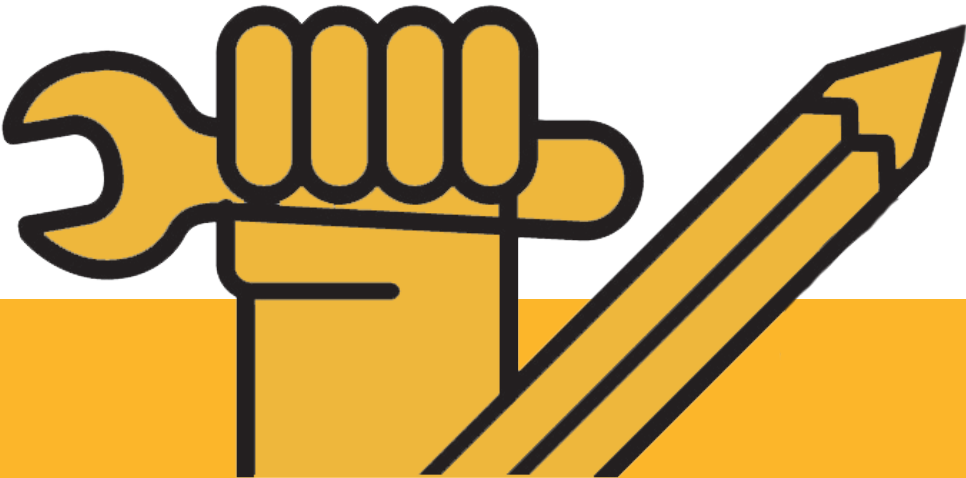

We feel better under pressure



Vitillo

Technical handbook

Index

- 5 Introduction
- 6 Hose and Fittings Terminology
 - Hydraulic fitting (generic definition)
 - Hydraulic hose (generic definition)
 - Hose assemblies
- 10 Design criteria for Hoses and Fittings
- 11 Selections of hose and fitting
 - Size
 - Pressure
 - Temperature
 - Fluid compatibility
 - Fittings
 - Environment
 - Choosing the right components
- 34 Hose Assembly Instructions
- 33 Correct Installation
- 41 Suggestions
- 46 Hose Troubleshooting
- 48 Identifying Fittings Type
 - NPTF
 - JIC 37*
 - BSPP- BSPT
 - O-RING BOSS
 - DIN 2353 24° CONE
 - SAE FLANGE (L-P-CATERPILLAR)
 - ORFS
- 69 Identification Fitting Types Chart
- 70 O-Ring

Introduction

We invest in quality and technology

We look after our customers

We grow with our values

Security is also Information

This technical handbook and catalogue will provide a guide to correct hose and fitting selection, as well as highlighting the important safety aspects to their usage as hose assemblies in the field.

Hose and Fittings Terminology

Hydraulic fitting (generic definition)

Hydraulic fittings are used to connect a hose assembly to a port or adapter and are manufactured to meet or exceed industrial specification requirements of SAE, ISO, DIN, DOT and JIS.

Vitillo's vast product offering of fittings are available in many configurations, including:

Straight fittings

45 degree elbow / 90 degree elbow fittings

Tee fittings

Vitillo's fitting product line includes jump and reducing fitting options.

Custom fittings are available in materials from

Carbon steel (with Chromium6-Free plating)

Stainless steel

Carbon steel (with Zinc-Nichelplating)



Hose and Fittings Terminology

Hydraulic hose (generic definition)

Typically a rubber hose is constructed of an extruded **inside synthetic rubber tube** that has the sole purpose of keeping the conveying fluid in the hose. The elastomeric nature of rubber requires that a reinforcement layer be wound or braided around the tube in order to hold the internal pressure. The **reinforcement layer(s) are steel** To protect these inner layers of the hose from the ambient conditions, an **outer synthetic rubber cover** is extruded around the reinforcement.

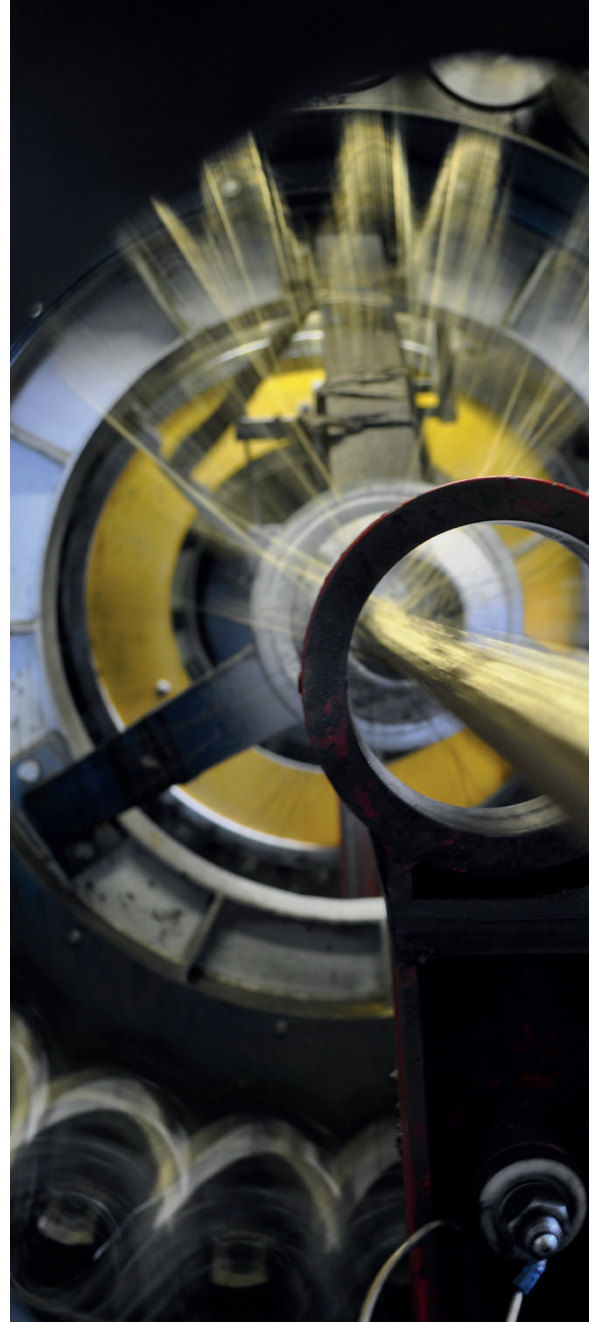
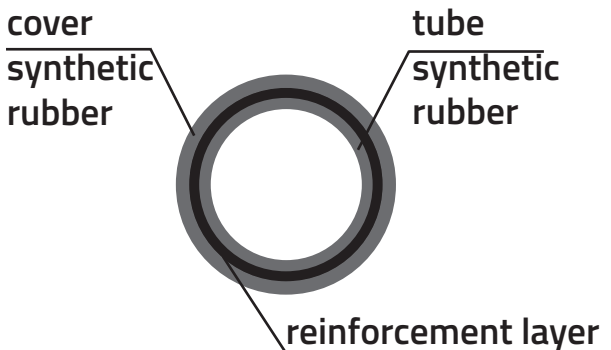

Hose and Fittings Terminology

The basic types of reinforcement are:

Braided reinforcement can be wire or textile and can have single or multiple layers.

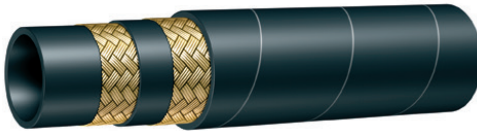

Spiraled reinforcement on hydraulic hose is typically wire or textile and has four or six layers (plies).

Spiral-reinforced hose can typically handle more severe applications with longer impulse service life.



Hose assemblies

The combination of a hose and hose fitting(s) to make a hose assembly, is a critical process that needs to be carried out by professionally trained personnel who follow strict assembly instructions. Improperly assembled hose fittings can separate from the hose and may cause serious injury or property damage from a whipping hose, or from fire or explosion of vapor expelled from the hose. The hose assembly must be operated within specific limits to maximize a safe and long term service life.

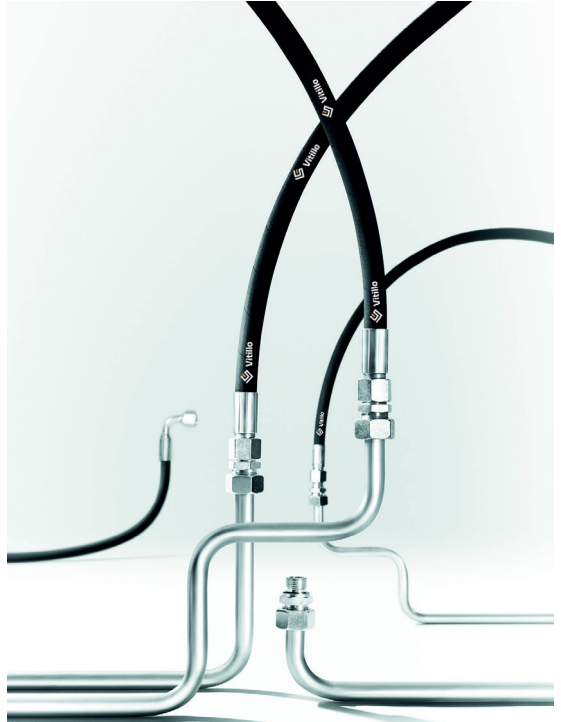

Design criteria for Hoses and Fittings

Ultimate target is to find the “best solution”

This solution provides:

- high system reliability
- easy assembly
- low maintenance
- low total cost

BEST SOLUTION

Pressure

After determining the system pressure, hose selection must be made so that the recommended maximum operating pressure is equal to or greater than the system pressure.

Fluid Compatibility

Hose selection must assure compatibility of the hose tube, cover, and fitting with the fluid used.

Abrasion

Investigate a hose with proven abrasion resistance

Temperature

Care must be taken to ensure that fluid and ambient temperatures do not exceed the limitations of the hose

Size

Transmission of power by means of pressurized fluid varies with pressure and rate of flow. The size of the components must be adequate to keep pressure drops to a minimum and avoid damage to the hose due to heat generation.

Specification-Standards

When selecting hose, government, industry, and manufacturer's specifications and recommendations must be reviewed as applicable with your designated Vitillo expert.

Selections of hose and fitting

Some applications allow a relatively simple hose selection, eg suction/return lines. Usually however, it is prudent to consider the points below and use them as a guide to help assure all factors have been taken into account. Using the data acquired from considering these points will lead to correct product choice and help assure safety, long service life and optimizes the overall cost of the hose assembly.

- a) Size
- b) Pressure
- c) Temperature
- d) Fluid compatibility
- e) Fittings
- f) Assembly
- g) Environment
- h) Choosing the right components

Selections of hose and fitting

a) Size

The power transmitted by means of a pressurized fluid varies with pressure and rate of flow.

The size of the components (hose and fittings) must be adequate to keep pressure drops to a minimum and avoid damage due to heat generation or excessive fluid velocity.

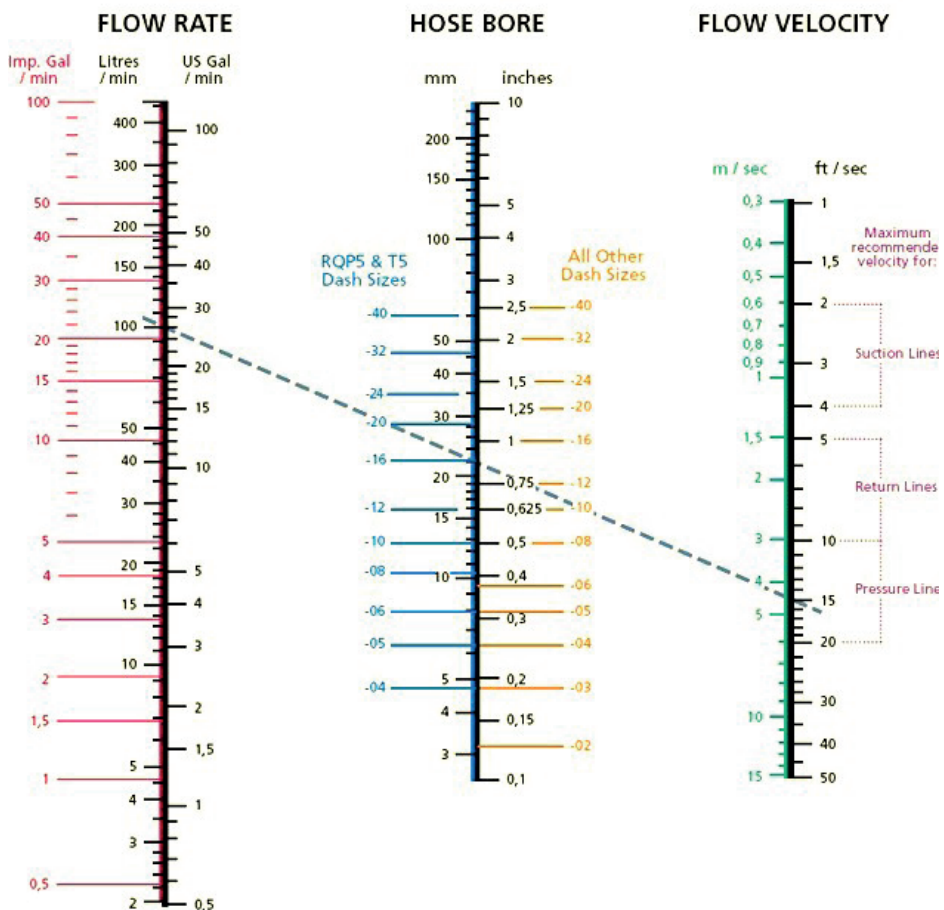

This chart is provided as an aid to determine the correct hydraulic hose size.

The diagram on page 12 is used to determine the correct hose size. For example: what is the correct hose size for a hydraulic system, when the recommended value for the fluid velocity is 50 l/m? When you find 50 l/min. in the column of left, and 7,6 metre/sec. in the column of right, you join the two points with a straight line. If the indicated inner diameter on the middle column is higher than 8 you have to use a inner diameter of -10 (5/8").

Identifying Hose I.D.

The DASH number is the I.D. of the hose in sixteenths of an inch. This size is a measurement of the inside tube of the hose. Dash number applies to the hose I.D. for all hoses except SAE100R5

Dash N°	Hose I.D.		nominal diameter
	in	mm	
-2	1/8	3.2	3
-3	3/16	4.8	5
-4	1/4	6.4	6
-5	5/16	7.9	8
-6	3/8	9.5	10
-8	1/2	12.7	12
-10	5/8	15.9	16
-12	3/4	19.0	20
-14	7/8	22.2	22
-16	1	25.4	25
-20	1 1/4	31.8	32
-24	1 1/2	38.1	38
-32	2	50.8	51

Example

DN	Inch	mm	size
-4	1/4" = 4/16"	4/16*25.4=	→ 6.35 = 6

Selections of hose and fitting

b) Pressure

Hose and fitting selection must be made so that the maximum recommended working pressure of the hose assembly is equal to or greater than the maximum system pressure. Surge pressures or peak pressures must be below this maximum working pressure.

The pressure rating of a hose assembly is determined by the pressure rating of the component in the hose assembly with the lowest working pressure.

Considering therefore only the pressure rating of the hose is NOT enough! Quite often the pressure rating of the fittings can lie below that of the hose; so to avoid any safety risks caused by non-compatibility of the fittings for the desired system pressure

Working Pressure

Hose and fitting selection must be made so that the published maximum recommended working pressure of the Hose and fitting are equal to, or greater than the maximum system pressure. Surge pressures or peak transient pressures in the system must be below the maximum working pressure of the hose assembly. Surge pressures and peak pressures can usually only be determined by sensitive electrical instrumentation that measures and indicates pressures at milli-second intervals. Mechanical pressure gauges indicate only average pressures and cannot be used to determine surge pressures or peak transient pressures.

Proof Pressure Test

This test is typically carried out by customer request according to a method defined by the ISO 1402 standard. The test should be made at normal ambient temperature with a proof test bench using water or another suitable liquid. The hose assembly should be pressurised for between 30 to 60 seconds at twice the working pressure of the hose assembly. There should be no leakage or pressure drop.

A complete test report should be provided together with the hose assembly to the customer.

Burst Pressure

All hoses in this catalogue have a pressure design factor of 4:1, implying therefore that the burst pressure (hose destruction) is minimum 4 times the published working pressure.

Published burst pressure ratings for hose are for manufacturing test purposes only – burst pressure should never play a role in the selection of a hose

Pressure Conversions

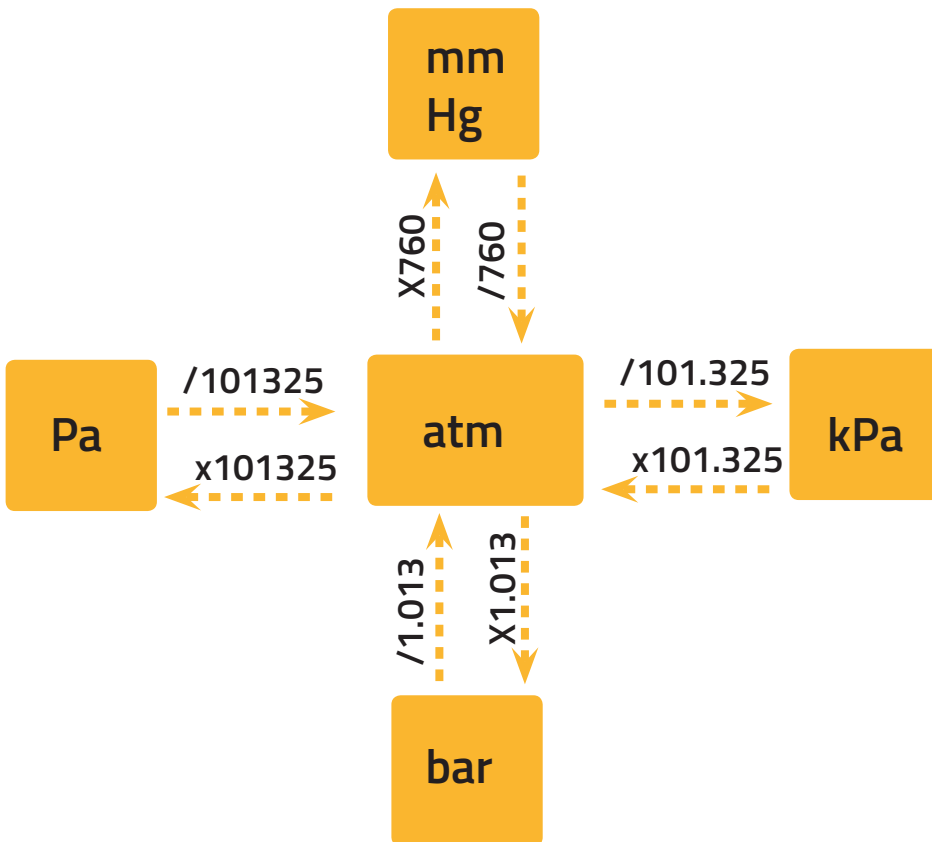

Selections of hose and fitting

c) Temperature

The temperature of the fluid in the hose and the ambient temperature around the hose in combination with the medium of both the conveyed fluid and the environment, need to be carefully considered in the hose selection process. The temperatures in the catalogue refer to the temperatures of the fluid in the hose.

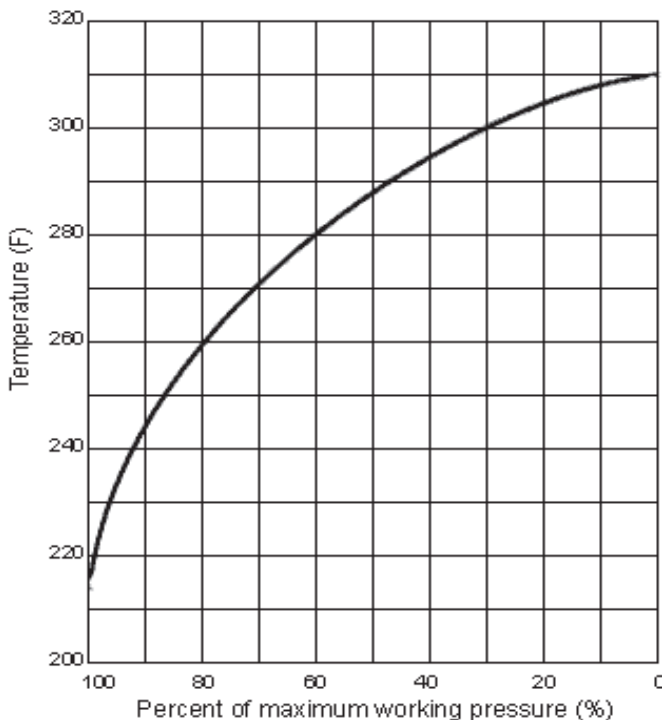

Entering the temperature in the graph, the maximum percentage of the working pressure is obtained

Pressure - Temperature

When working at high temperatures, the operating pressure must be reduced. Temperature and pressure reductions in a hydraulic system must take into consideration the construction material used to fabricate the hose. Male stud couplings may require extra pressure reductions, related to the material where the fitting is screwed in to the sealing system.

The working temperatures depend on the materials

(also influenced by the operating medium):

for fittings in carbon steel

-40°C up to +200°C

for seal materials NBR

-35°C up to +100°C

Steel

Pressure reduction for working temperatures TB in °C

-60°C - +120°C	0%
+150°C	11%
+175°C - +200°C	19%
+250°C	25%

Celsius to Fahrenheit

°C	°F	°C	°F	°C	°F	°C	°F
-24	-11.2	1	33.8	26	78.8	51	123.8
-23	-9.4	2	35.6	27	80.6	52	125.6
-22	-7.6	3	37.4	28	82.4	53	127.4
-21	-5.8	4	39.2	29	84.2	54	129.2
-20	-4	5	41	30	86	55	131
-19	-2.2	6	42.8	31	87.8	56	132.2
-18	-0.4	7	44.6	32	89.6	57	134.6
-17	1.4	8	46.4	33	91.4	58	136.4
-16	3.2	9	48.2	34	93.2	59	138.2
-15	5	10	50	35	95	60	140
-14	6.8	11	51.8	36	96.8	70	158
-13	8.6	12	53.6	37	98.6	80	176
-12	10.4	13	55.4	38	100.4	90	194
-11	12.2	14	57.2	39	102.2	100	212
-10	14	15	59	40	104	110	230
-9	15.8	16	60.8	41	105.8	120	248
-8	17.6	17	62.6	42	107.6	130	266
-7	19.4	18	64.4	43	109.4	140	284
-6	21.2	19	66.2	44	111.2	150	302
-5	23	20	68	45	113	160	320
-4	24.8	21	69.8	46	114.8	180	356
-3	26.6	22	71.6	47	116.6	200	392
-2	28.4	23	73.4	48	118.4	250	482
-1	30.2	24	75.2	49	120.2	300	572
0	32	25	77	50	122	400	752

Selections of hose and fitting

d) Fluid compatibility

It is vital for long service life and leak free function that the hose assembly (hose inner tube, hose outer cover and hose fittings and O-rings) be chemically compatible to both the fluid being conveyed through the hose as well as the environment of the hose.

These notes shall be intended only as a guide to chemical compatibility with the internal fluid and is not a guarantee.; other combined factors in working operations, as pressure, temperature, vibrations and so on, may impact on the service life.

Legend

A: It corresponds to excellent chemical resistant, with minimum or no properties changes.

B: It corresponds to a limited chemical resistance, with moderately acceptable property changes.

C: It corresponds to an incompatible or dangerous situation which could result in failure or injury.

FLUID COMPATIBILITY CHART

	ISO 6743-4	TEKNO TH/17 TEKNOJACK FORTHREE TEKNOMASTER SLIM SERVOCOMANDO LIFT-PLUS PREMIER	TEKNOSPIR ELASTIK TEKNOBLAST	VULCAN
AGIP				
ARNICA 46	HV	B	A	-
ARNICA EXTRA PLUS	HEES	B	B	-
ARNICA PLUS	HEES	B	A	-
ARNICA S46	HFDU	B	A	-
OSO 32	HM	C	A	-
OSO D46	HM	C	B	-
AVIA				
BIOFLUID BP32	HEES	B	B	-
FLUID RSL 32	HS	B	A	-
HVI 46	HV	B	B	-
SYNTOFLUID F46	HEES	A	A	-
SYNTOFLUID N32	HEES	A	B	-
SYNTOFLUID N46	HEES	B	A	-
SYNTOFLUID PE B 30 PAO	HEPR	B	A	-
SYNTOFLUID PE B 50 PAO	HEPR	C	B	-
CASTROL				
AERO HF 585 B (MIL 56006H)	HH	B	A	-
ANVOL SWX 68 (POE based)	HFDU	A	A	-
BIOTECH ALPIN 22	HETG	A	A	-
BRAYCO 717 (MIL17111c)	HS	B	B	-
CARELUBE HTG	HETG	A	A	-
CARELUBE HY 46	HEES	B	B	-
HYSPIN HDH 7000	HM	B	A	-
LIFT OIL	HH	B	B	-
PRODUCT L 320	HH	B	A	-
PRODUCT L 571	HH	B	A	-

Selections of hose and fitting

FLUID COMPATIBILITY CHART

ISO 6743-4 TEKNO TH/17
TEKNOJACK
FORTHREE
TEKNOMASTER
SLIM
SERVOCOMANDO
LIFT-PLUS
PREMIER

TEKNOSPIR
ELASTIK
TEKNOBLAST

VULCAN

CHEVRON

AW 46	HM	B	A	-
HYDRAULIC AW 46	HM	B	A	-
MACHINE OIL AW 220	HV	B	B	-
MACHINE OIL AW ISO 46	HV	B	B	-
RANDO HD 68	HM	C	B	-
RYCON MV	HM	B	A	-

ESSO

HYDRAULIKOEL HE 46	HEES	A	A	-
NUTO H46	HM	B	B	-
UNIVIS N46	HV	B	A	-

FUCHS

ECO HYD 46S NWG	HEES	B	B	-
OM13	HH	B	B	-
OM65	HH	B	B	-
PLANTOHYD 46S	HEES	A	A	-
PLANTOHYD N46	HETG	A	B	-
PLANTOHYD SUPER S46	HEES	A	B	-
PLANTOSYN 3268 ECO	HEES	A	B	-
PLANTOSYN 46 HVI	HEES	B	A	-
RENOLIN B15 VG46	HV	B	B	-
RENOLIN MR 520	HV	B	B	-

HOUGHTON

COSMOLUBRIC HF130 (POE based)	HFDU	C	B	-
HYDRAVIS BC 84005 (60°C)	HFC	A	A	-
ISOCORE E68 PLUS	HFC	A	A	-
SAFE 620	HFC	B	B	-
SAFE CTF	HFC	A	A	-
SAFE OX40	HFC	A	A	-
VITAL FLUID L46AL	HFDU	A	B	-
SAFE 273 CTF	HFC	A	A	-

FLUID COMPATIBILITY CHART

	ISO 6743-4	TEKNO TH/17 TEKNOJACK FORTHREE TEKNOMASTER SLIM SERVOCOMANDO LIFT-PLUS PREMIER	TEKNOSPIR ELASTIK TEKNOBLAST	VULCAN
MOBIL				
AERO HF 468MIL5606H)	HH	B	A	-
ARCTIC EAL 224H	HETG	A	B	-
DTE 10 EXCEL 68	HV	C	B	-
DTE 13	HV	C	A	-
DTE 24	HV	B	B	-
DTE 25	HV	B	A	-
DTE 26	HV	B	B	-
DTE EXCEL 46	HM	C	B	-
DTE EXCEL 68	HM	-	B	-
DTE FM 32	HM	C	A	-
HYDROFLUID HFDU	HFDU	A	A	-
SHC 524	HM	C	A	-
PANOLIN				
EP GEAR SYNTH 30 VDT	HEES	B	B	-
GRO SYNTH 46	HEES	B	B	-
HLP SYNTH 15	HEES	C	B	-
HLP SYNTH 46	HEES	B	A	-
HLP SYNTH E46	HEES	B	A	-
HLP UNI 46	HV	B	A	-
TRAFOSYNTH 2	HEES	B	B	-
Q8				
HANDEL 68	HV	C	B	-
HAYDIN	HM	B	A	-
HELLER 46	HV	B	A	-
HOGARTH	HV	C	B	-
HOLBEIN	HEES	B	A	-
HUMMEL 46	HM	C	A	-

Selections of hose and fitting

FLUID COMPATIBILITY CHART

	ISO 6743-4	TEKNO TH/17 TEKNOJACK FORTHREE TEKNOMASTER SLIM SERVOCOMANDO LIFT-PLUS PREMIER	TEKNOSPIR ELASTIK TEKNOBLAST	VULCAN
QUAKER				
GREENSAVE N40	HETG	B	B	-
QUINTOLUBRIC 888	HFDU	B	B	-
QUINTOLUBRIC 888-46	HFDU	B	B	-
QUINTOLUBRIC 888-68	HFDU	B	B	-
QUINTOLUBRIC N822-300	HFDU	B	B	-
QUINTOLUBRIC N852	HEES	B	B	-
SHELL				
AEROSHELL FLUID 41 (MIL5606H)	HH	B	A	-
AEROSHELL FLUID 602 (MIL-PRF 87252C)	HEPR	B	A	-
ASTRON HL46	HH	B	A	-
DONAX TA	HM	C	-	-
IRUS FLUID DU-NA 46	HFDU	A	A	-
IRUS FLUID DU-NA 68	HFDU	A	A	-
NATURELLE HF-E15	HEES	B	A	-
NATURELLE HF-E46	HEES	B	A	-
TARGON AL PLUS	HH	A	A	-
TELLUS ARCTIC 32	HM	B	B	-
TELLUS S1 M46 (ex TELLUS H46)	HM	B	B	-
TELLUS S2 M100 (ex TELLUS 100)	HM	B	A	-
TELLUS S2 M46 (ex TELLUS 46)	HM	B	A	-
TELLUS S2 M68 (ex TELLUS 68)	HM	B	A	-
TELLUS S2 V32 (ex TELLUS T32)	HV	B	A	-
TELLUS S2 V46 (ex TELLUS T46)	HV	B	A	-
TELLUS S2 V68 (ex TELLUS T68)	HV	B	A	-
TELLUS S46	HM	B	A	-
TELLUS S4ME46 (ex TELLUS EE46)	HM	-	A	-
TELLUS TX68	HV	C	B	-

FLUID COMPATIBILITY CHART

ISO 6743-4 TEKNO TH/17
TEKNOJACK FORTHREE
TEKNOMASTER SLIM
SERVOCOMANDO LIFT-PLUS
PREMIER

TEKNOSPIR ELASTIK
TEKNOBLAST

VULCAN

TEXACO

BIOSTAR HYDRAULIC 32	HETG	A	A	-
HYDRA 46	HEES	B	A	-
RANDO HD 46	HM	B	A	-
RANDO HD LVZ 46	HV	C	B	-
RANDO HD VZ	HV	B	B	-
RANDO HD Z 46	HV	B	A	-
SYNSTAR HT 68	HFDU	A	B	-
AZOLLA HZS 46	HM	C	A	-
AZOLLA ZS 46	HM	B	A	-
BYOHYDRAN SE 46	HEES	B	B	-
EQUIVIS ZS 46	HV	B	B	-
HYDRANSAFE HFDU 46	HFDU	B	A	-

These notes shall be intended only as a guide to chemical compatibility with the internal fluid and is not a guarantee.; other combined factors in working operations, as pressure, temperature, vibrations and so on , may impact on the service life.

Selections of hose and fitting

OTHER FLUID

	TEKNO TH/17 TEKNOJACK FORTHREE TEKNOMASTER SLIM SERVOCOMANDO LIFT-PLUS PREMIER	TEKNOSPIR ELASTIK TEKNOBLAST	VULCAN
A			
ACETALDHEIDE	C	C	C
ACETIC ACID 50%	C	B	-
ACETIC ACID GLACIAL	C	C	C
ACETONE (Dimethylketone)	C	C	C
AEROSHELL TYPE 1A,1AC,4	A	B	-
AEROSHELL 7A GREASE	A	B	-
AEROSHELL 17 GREASE	A	B	-
AEROSHELL 750	B	C	-
AIR (65 °C)	B	B	A
AIR (80 °C)	B	B	A
AIR (135 °C)	C	C	A
AMMONIA (Acqueous up to 30% NH ₃)	A	A	A
AMMONIUM HYDROXIDE up to 30% NH ₃	B	B	A
AMMONIUM NITRATE (aqueous solutions up to 83%)	A	A	A
AMMONIUM PHOSPHATE,mon-di-tri badic (aq. Sol.)	A	A	A
AMMONIUM SULFIDE (aqueous solutions up to 40%)	B	C	A
ANDEROL L-774	B	C	-
ANDEROL L-826	B	C	-
ANDEROL L-829	B	C	-
ANILINE	C	C	C
AQUA REGIA	C	C	C
ASTM OIL N° 1, 100 °C	A	A	B
ASTM OIL N° 2, 100 °C	A	B	B
ASTM OIL N° 3, 100 °C	A	B	C
ASTM FUEL A (ISO-OCTANE)	A	A	A
ASTM FUEL B (70% ISO-OCTANE, 30% TOLUENE)	A	B	C
ASTM FUEL C (50% ISO-OCTANE, 50% TOLUENE)	A	C	C

OTHER FLUID

	TEKNO TH/17 TEKNOJACK FORTHREE TEKNOMASTER SLIM SERVOCOMANDO LIFT-PLUS PREMIER	TEKNOSPIR ELASTIK TEKNOBLAST	VULCAN
B			
BENZENE	C	C	C
BORIC ACID 10% 100 °C	A	A	A
BUTANOL	A	B	B
C			
CALCIUM CARBONATE	A	A	A
CALCIUM HYDROXIDE (hydrated or slaked lime)	B	A	A
CARBON DIOXIDE DRY(GAS)	A	A	A
CARBON DIOXIDE WET(GAS WITH WATER VAPOR)	A	A	A
CARBONIC ACID	A	A	A
CHLOROFORM	C	C	C
CITRIC ACID SOLUTION	B	A	B
CRUDE OIL	A	B	B
D			
DIBENZYL ETHER	C	C	C
DIBUTYL PHTHALATE (DBP)	C	C	C
DIESEL FUEL (70 °C)	A	B	C
E			
ETHYL ACETATE	C	C	C
ETHYL ALCOHOL	A	A	A
ETHYL ETHER	C	C	C
ETHYLENE GLYCOLE	A	A	B

Selections of hose and fitting

OTHER FLUID

	TEKNO TH/17 TEKNOJACK FORTHREE TEKNOMASTER SLIM SERVOCOMANDO LIFT-PLUS PREMIER	TEKNOSPIR ELASTIK TEKNOBLAST	VULCAN
F			
FORMALDHEYDE SOLUTION UP TO 50%	B	B	B
FORMIC ACID	-	A	B
G			
GLYCERINE	A	A	A
GREASE, ESTER BASE	-	-	-
GREASE, PETROLEUM BASE	A	B	B
GREASE, SILICONE BASE	-	-	-
H			
HEPTANE	A	B	C
HYDROCHLORIC ACID, 15%	C	C	B
HYDROCHLORIC ACID, 37%	C	C	B
HYDROCYANIC ACID 10%	C	C	B
HYDROGEN SULPHIDE, LIQUIFIED	C	B	-
I			
ISOBUTYL ALCOHOL	B	B	A
ISOPROPYL ALCOHOL	A	B	B
K			
KEROSENE (aromatics 40% max, 70°C)	A	C	C
L			
LARD (Fat of the Hog up to 40°C)	A	B	-
LUBRICATING OIL SAE 10,20,30,	B	B	-
LUBRICATING OILS (DIESTER UP TO 55°C)	B	C	-

OTHER FLUID

TEKNO
TH/17
TEKNOJACK
FORTHREE
TEKNOMASTER
SLIM
SERVOCOMANDO
LIFT-PLUS
PREMIER

TEKNOSPIR
ELASTIK
TEKNOBLAST

VULCAN

	TEKNO TH/17 TEKNOJACK FORTHREE TEKNOMASTER SLIM SERVOCOMANDO LIFT-PLUS PREMIER	TEKNOSPIR ELASTIK TEKNOBLAST	VULCAN
M			
MERCURY	B	A	A
METHANOL	A	A	A
METHYL METHACRYLATE	C	C	B
METHYLETHYLKETONE (MEK)	C	C	C
MOTOR OIL UP TO 55°C	A	B	B
N			
NITRIC ACID concentrated 65%	C	C	C
NITRIC ACID diluted 10% 50°C	C	C	B
NITRIC ACID FUMING	C	C	C
NITROGEN GAS	A	A	A
O			
OIL SAE UNDER 40°C	A	A	B
OILS, CRUDE	B	C	-
OLEIC ACID	B	B	C
OLEUM	C	C	C
OXALIC ACID 50%	C	C	B
OXYGEN 80°C	B	-	A
P			
PARAFFIN	A	B	C
PHENOL	C	C	C
PHOSPHORIC ACID 35%	B	B	A
PHOSPHORIC ACID 50%	B	B	A
PHOSPHORIC ACID 85%	C	C	A
PICRIC ACID	B	B	B
POTASSIUM HYDROXIDE 45% CAUSTIC POTASH	B	C	C
POTASSIUM SULFIDE	A	A	B

Selections of hose and fitting

OTHER FLUID

	TEKNO TH/17 TEKNOJACK FORTHREE TEKNOMASTER SLIM SERVOCOMANDO LIFT-PLUS PREMIER	TEKNOSPIR ELASTIK TEKNOBLAST	VULCAN
S			
SEA WATER	B	B	B
SOAP SOLUTION	A	B	B
SODIUM BICARBONATE	A	A	A
SODIUM CHLORIDE	A	A	A
SODIUM HYDROXIDE 40%	B	A	A
SODIUM HYPOCHLORITE (aqueous solution)	C	C	A
SODIUM SILICATE	A	A	A
SODIUM SULFATE	A	A	A
SODIUM SULFIDE	A	A	A
STEARIC ACID	B	B	B
SULPHUR DIOXIDE LIQUID	C	B	B
SULFURIC ACID	C	C	C
SULPHURIC ACID DILUITED 20%	B	A	A
T			
TANNIC ACID	C	B	B
TETRAETHYL LEAD	B	C	C
TOLUENE	C	C	C
TURPENTINE	B	C	C
U			
UREA	B	A	A
V			
VINYL ACETATE	C	C	C
VINYL CHLORIDE	C	C	C
W			
WATER	A	A	A
X			
XYLENE	C	C	C
Z			
ZINC CHLORIDE (aqueous solutions)	A	A	A
ZINC SULPHATE (aqueous solutions)	B	B	B

FLUID COMPATIBILITY CHART FOR PRESS FITTINGS AND ADAPTORS

FITTING AND ADAPTORS CARBON STEEL

ACETYLENE	B
AIR (OIL FREE) @ 190°F	B
AIR (OIL FREE) @ 300°F	B
AIR (OIL FREE) @ 400°F	B
ALCOHOL ETHYL	C
ANIMAL OILS (LARD OIL)	B
AROMATIC FUEL - 50%	-
AROMATIC SOLVENTS	-
ASPHALT	C
ASTM OIL #1	A
ASTM OIL #2	A
ASTM OIL #3	A
ASTM OIL #4	AQ
ATF OIL	A
AUTOMOTIVE BRAKE FLUID	-
B	
BENZENE	B
BRINE (SODIUM CHLORIDE)	C
BUTANE	A
C	
CARBON DIOXIDE	B
CARBON MONOXIDE	A
CHLORINE (DRY)	B
COMPRESSED AIR	B
CRUDE OIL	B
CUTTING OIL	A
D	
DIESEL FUEL	A

Selections of hose and fitting

FITTING AND ADAPTORS CARBON STEEL

FITTING AND ADAPTORS	CARBON STEEL
E	
ETHANOL	C
ETHERS	C
F	
FREON 11	-
FREON 12	A
FREON 22	C
FUEL OIL	A
G	
Gasoline	B
Gas, Liquid Propane (LPG)	A
Gas, Natural	A
H	
Helium	A
Hydraulic Oil, Petroleum Base	A
Hydraulic Oil, Water Base	A
Hydrogen Gas	A
K	
Kerosene	A
L	
Lubricating Oil SAE 10, 20, 30, 40, 50	A
M	
Methanol	A
Mineral Oil	A
N	
Nitrogen	A
P	
Petrolatum	A
Petroleum Oil (<250°F)	A
Propane	A
R	
R134A	A

FITTING AND ADAPTORS

CARBON STEEL

S

Sea Water	C
Skydrol 500, Type 2	A
Skydrol 7000, Type 2	A
Soap Solutions	C
Steam (<400°F)	A
Stoddard Solvent	A

T

Transmission Fluid (Type A)	A
Trichloroethane	B

W

Water	B
-------	---

These notes are intended as a guide only. Chemical compatibility with internal fluids is not a guarantee. Other factors such as working pressure, temperature, vibrations and operating environment, affect service life and must be taken into consideration.

Selections of hose and fitting

f) Fittings

Hose ends, or hose fittings as commonly named, tend to be specified by the machine port that the hose is to be attached to and are heavily influenced by the country of origin.

Despite many efforts being made to standardize and rationalize connection types, many connection systems still exist due to national or international standards or even specific to a customer or a market segment.

In general there are five main fittings systems generally used for hydraulic connections today, whereby the overall list is much longer. In order to assure a long service life and leak free running of the system the fitting style and the sealing type of the fitting should be considered in the design process.

Thread Types:

GERMAN	- (DIN)
FRENCH	- (GAS & METRIC)
BRITISH	- (BSP)
NORTH AMERICAN	- (SAE)
JAPANESE	- (JIS)

g) Environment

To insure maximum service life and safety the routing of a hose assembly should be made to avoid, stretching, compressing, kinking or the hose coming into contact with sharp edges. Care must be taken to ensure that the hose and fittings are either compatible with or protected from the environment to which they are exposed. Environmental conditions including but not limited to ultraviolet light, heat, ozone, moisture, water, salt water, chemicals, and air pollutants can cause degradation and premature failure and, therefore, must be considered.

h) Choosing the right components

Safe, long-lasting hydraulic assemblies begin by choosing the right components. The “right” components are couplings, hoses, crimping equipment and accessories that are all designed to work together. Not all manufacturers offer safe, high-quality components. Mixing and matching couplings from one manufacturer with hoses from another manufacturer can lead to premature or catastrophic assembly failure.

That’s because hoses, couplings, assembly equipment and crimping tolerances vary from one manufacturer to another, and they’re not interchangeable. When components from different manufacturers are mixed together, coupling retention can be adversely affected. Mixing components can not only cause unnecessary downtime, it can result in personal injury as well. In addition, the thread or flange ends of couplings must be properly matched to their mating components to create leak-proof connections.

Hose Assembly Instructions

Following the recommended practices for hose and fitting assembly and installation you will achieve a longer service life and greater safety. The proper connection choice is very important for the optimal use and safe operation of the assembly.

Method of Crimping

Crimping takes place when a metal bushing referred to as a ferrule is placed over a hose and a fitting is inserted into the hose. The ferrule is compressed to a predetermined outside diameter trapping the hose between the ferrule and the fitting.

A) Calculate the length of the hose to be cut C

The hose cut length for a hose assembly is calculated by subtracting the cut-off factor (distance from the bottom of the ferrule end of the fitting), denoted as A

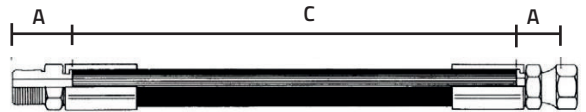

B) Cut the hose at right angles to the desired length using a specific disc cutter.

Finished the cut make sure that there are no residues within the tube



C) Ensure hose is cut squarely, also clean the hose bore after cutting.



D) In certain situations, (fittings skive and interlock), skiving may be required. Skiving is the process of removing the cover of hose to allow the proper installation of crimped hose ends. **Read our crimping chart on our website to check the length of the skiving suitable for the fitting used.**

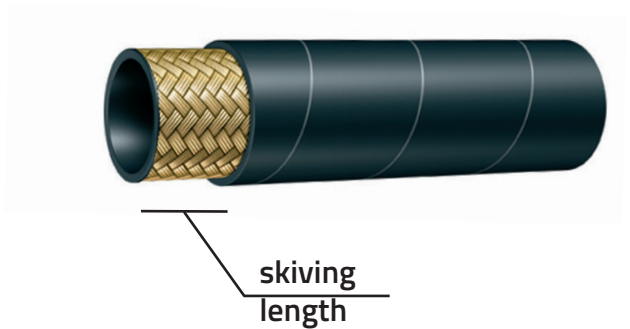

E) Insert the ferrule on the hose, insert the tang and if necessary, lubricate with compatible hydraulic oil. The 2piece crimped fitting consists of a ferrule and a stem insert. It is essential that the fitting be mated with a compatible hose style.



F) The shoulder of the stem should make contact with ferrule, if you install an elbow make sure the angle is right.

G) Before carrying out the pressing, with the aid of a gauge, measure the internal diameter of the shank in the vicinity of the centerline.



Hose Assembly Instructions

H) Choose the dies most suitable to perform the pressing. Place the end of the tube between the punches ensuring that the positioning is such as to allow the pressing of the entire length of the bushing. Pressing up to the dimension indicated in the crimping chart.



I) Check the internal diameter of the stem with go - no go gauge to ensure the compliance with the values given in the tables of collapse of pressing.



L) It is good practice to examine the assembly prior to delivery or use. The level of control must be in accordance with the quality plan.

Visual and dimensional inspection.

-Clean and flush to remove dust, chips, gum, etc.

-Apply caps to keep out contamination.

-Apply labels if required.



Correct Installation

Satisfactory performance and appearance depend upon proper hose installation. Excessive length destroys the trim appearance of an installation and adds unnecessarily cost to the equipment. Hose assemblies of insufficient length to permit adequate flexing, expansion or contraction will cause poor power transmission and shorten the life of the hose

Abrasion

Run hose in the installation so that it avoids rubbing and abrasion. Often, clamps are required to support long hose runs or to keep hose away from moving parts. Use clamps of the correct size. Too large a clamp allows hose to move inside the clamp and cause wear.

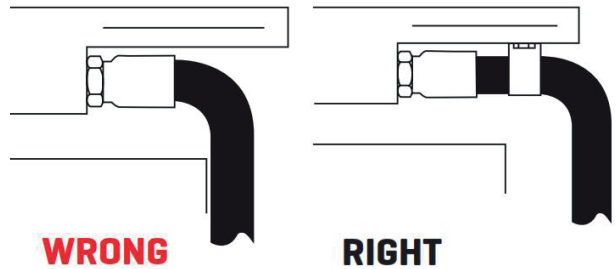

Appearance

Route hose directly by using 45° and/or 90° adapters and fittings. Avoid excessive hose length to improve appearance.

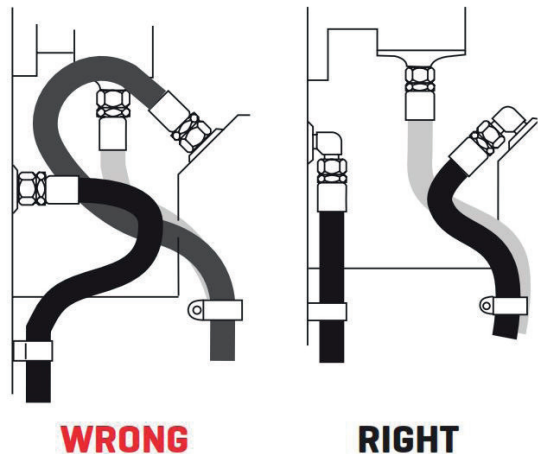

Correct Installation

Collapse

To avoid hose collapse and flow restriction, keep hose bend radius as large as possible. Refer to hose specification tables for minimum bend radius.

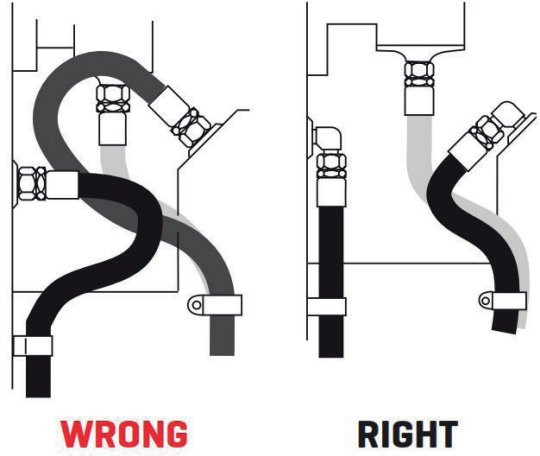

High Heat

High ambient temperatures shorten hose life, so make sure hose is kept away from hot parts. If this is not possible, insulate hose with protective sleeving.

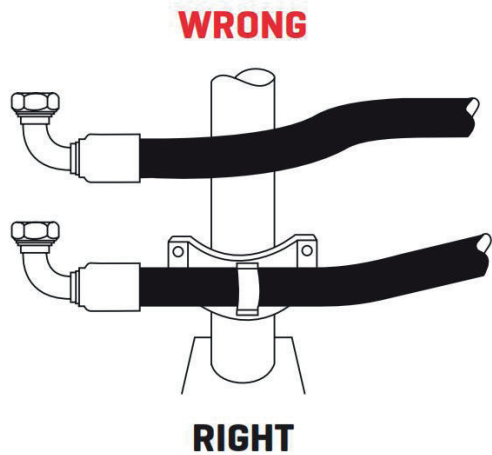

Length Change

When hose installation is straight, allow enough slack in hose line to provide for length changes that will occur when pressure is applied.

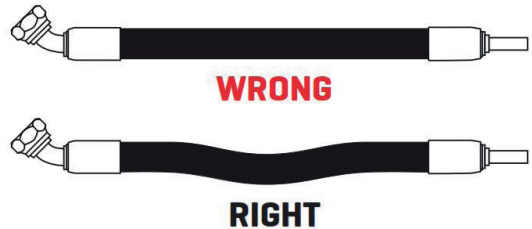

Movement/Flexing

Adequate hose length is necessary to distribute movement on flexing applications and to avoid abrasion.

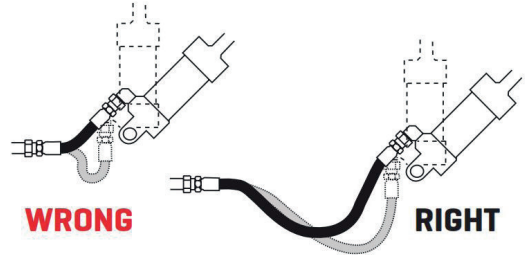

Reduce Connections

Reduce the number of pipe thread joints by using hydraulic adapters instead of pipe fittings.

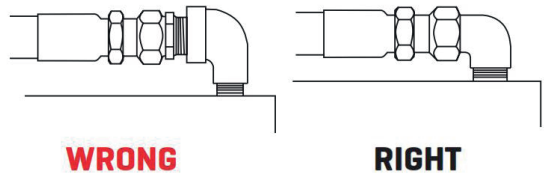

Strain

Elbows and adapters should be used to relieve strain on the assembly, and to provide neater installations which will be more accessible for inspection and maintenance.

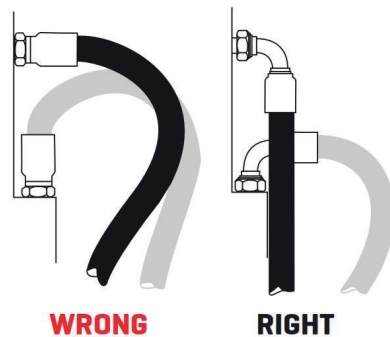

Correct Installation

Strain

When radius is below the required minimum, use an angle adapter to avoid sharp bends.

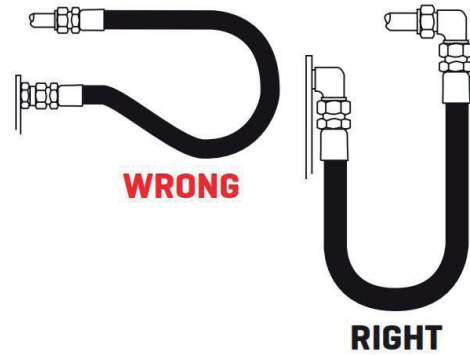

Twist

Prevent twisting and distortion by bending hose in same plane as the motion of the port to which hose is connected.

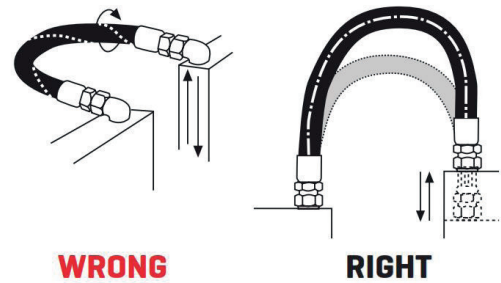

Twist

When installing hose, make sure it is not twisted. Pressure applied to a twisted hose can result in hose failure or loosening of connections.

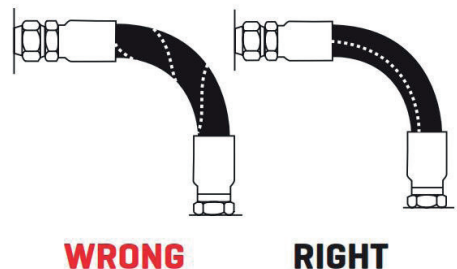

Suggestions

IMPORTANT NOTE FOR USERS

Hose assemblies require caution in use not only to provide long service life but also to guard against potentially dangerous failure. Serious injury, death and destruction of property can result from the rupture or blowing a part of a hose assembly that is damaged, worn out, badly assembled or installed incorrectly. Users should follow good maintenance practices. Avoid expensive downtime by establishing a program of inspection, testing and replacement of hose assemblies before failure occurs; taking into account factors including: severity of application, frequency of equipment use, past performance of hose assemblies. Document your maintenance, inspections and testing. Only properly trained persons should inspect, test or service hose assemblies and this training should be updated regularly. Users should carefully observe the precautions listed below as well as following closely our recommendations for the selection of hose and couplings. In addition, care should be taken not to go below the minimum bend radius listed for each hose size and type. Maximum operating pressure and temperature should not exceed the pressures listed. Instruction for assembling fittings to different hoses should be followed carefully to ensure the safe performance of the complete assembly. By following the recommendations on hose assembly routing and installation improved safety and longer service life of any hose installation will result. Fluid under pressure can be potentially dangerous!

A fluid leak can cause damage to equipment as well as serious injury to persons nearby.

SALIENT INFORMATION

Highly pressurized gas and/or oil escaping from a small pinhole can be almost invisible and, yet, exert extreme force capable of penetrating the skin and other body tissues, causing possible severe injury. Hot fluids or chemicals can cause severe burns. Pressurized fluids, if released uncontrolled, can exert a tremendous explosive force. Some fluids are highly flammable.

PRECAUTIONS

Always position a shield between you and any pressurized lines when working next to them or shut the pressure off. Wear safety glasses. Do not use your hands to check for leaks. Do not touch a pressurized hose assembly with any part of your body, if fluid punctures the skin, even if no pain is felt, a serious emergency exists. Obtain medical assistance immediately. Failure to do so can result in loss of the injured body part or death. Stay out of hazardous areas while testing hose assemblies under pressure. Use proper safety protection. If an injury or reaction occurs, get medical attention right away. Hose (and hose assemblies) has a limited life dependent on service conditions to which it is applied. Subjecting hose (and hose assemblies) to conditions more severe than the recommended limits significantly reduce service life. Exposure to combinations of recommended limits (i.e. continuous use at maximum rated working pressure, maximum recommended operating temperature and minimum bend radius) will also reduce service life.

Suggestions

ROUTING

Attention must be given to optimum routing to minimize inherent problems. Restrain, protect or guide hose with the use of clamps if necessary to minimize damages due to excessive flexing, whipping or contact with other moving parts or corrosives. Determine hose lengths and configurations that will result in proper routing and protection from abrasion, snagging or kinking and provide leak resistant connections.

ENVIRONMENT

Care must be taken to ensure that the hose and fittings are either compatible with or protected from the environment to which they are exposed. Environmental conditions including but not limited to ultraviolet light, heat, ozone, moisture, water, salt water, chemicals, and air pollutants can cause degradation and premature failure and, therefore, must be considered.

RADIATION

Radiation affects all materials used in hose assemblies. Since the long-term effects may be unknown, do not expose hose assemblies to atomic radiation.

MECHANICAL LOADS

External forces can significantly reduce hose life. Mechanical loads which must be considered include excessive flexing, twist, kinking, tensile or side loads, bend radius, and vibration. Use of swivel type fittings or adaptors may be required to ensure no twist is put into the hose. Unusual applications may require special testing prior to hose selection.

ABRASION

While a hose is designed with a reasonable level of abrasion resistance, care must be taken to protect the hose from excessive abrasion which can result in erosion, snagging, and cutting of the hose cover. Exposure of the reinforcement will significantly accelerate hose failure.

SPECIFICATIONS AND STANDARDS

When selecting hose and fittings, government, industry and manufacturer's specifications and recommendations must be reviewed as applicable.

STATIC-ELECTRIC DISCHARGE

Fluid passing through hose can generate static electricity resulting in static electric discharge. This may create sparks that can puncture hose. If this potential exists, select hose with sufficient conductivity to carry the static-electric charge to the ground.

MINIMUM BEND RADIUS

Installation of a hose at less than the minimum listed bend radius may significantly reduce the hose life. Particular attention must be given to avoid sharp bending at the hose/fitting juncture.

TWIST ANGLE AND ORIENTATION

Hose installations must be such that relative motion of machine components does not produce twisting.

SECUREMENT

In many applications, it may be necessary to restrain, protect, or guide the hose to protect it from damage by unnecessary flexing, pressure surges and contact with other mechanical components. Care must be taken to ensure such restraints do not introduce additional stress or wear points.

PROPER CONNECTION OF PORTS

Proper physical installation of the hose requires a correctly installed port connection while ensuring that no twist or torque is transferred to the hose.

EXTERNAL DAMAGE

Proper installation is not complete without ensuring that tensile loads, side loads, kinking, flattening, potential abrasion, thread damage, or damage to sealing surfaces are corrected or eliminated.

UNINTENDED USES

Hose assemblies are primarily designed for the internal forces of conducted gas and/or oil. Do not pull hose or use it for purposes that may apply external forces for which the hose or fittings were not designed.

HOSE AND FITTING MAINTENANCE INSTRUCTIONS

Even with proper selection and installation, hose life may be significantly reduced without a continuing maintenance program. Frequency should be determined by the severity of the application and risk potential. A maintenance program must be established and followed to include the following as a minimum:

VISUAL INSPECTION HOSE/FITTING

Any of the following conditions require immediate shut down and replacement of the hose assembly: Damaged, cut or abraded cover (any reinforcement exposed). Hard, stiff, heat cracked, or charred hose. Cracked, damaged, or badly corroded fittings. Leaks at the fitting or in the hose. Kinked, crushed, flattened or twisted hose. Blistered, soft, degraded, or loose cover.

VISUAL INSPECTION ALL OTHER

The following items must be tightened, repaired or replaced as required: Leaking port conditions, clamp, guards, shields, system fluid level, fluid type and any air entrapment. Remove excess dirt..

Suggestions

PERIODIC INSPECTIONS

Periodic hose assembly inspections can prevent unwanted and unexpected assembly failures. During normal operations, be aware of how the equipment sounds, feels, etc. Be sure to check any noticeable abnormalities.

Hose inspection can vary by equipment type. Refer to your equipment manual and always follow the manufacturer's inspection recommendations. If the recommendations are not available, use the following guidelines:

- Inspect stationary equipment every three months.
- Inspect mobile equipment every 400 to 600 hours or every three months, whichever comes first.

Other factors that influence inspections include:

- Whether the equipment is critical to the operation.
- Operating pressures and temperatures.
- Difficult routing conditions.
- Extreme environmental factors.
- Accessibility of equipment.

Here's a checklist to help keep your equipment running strong:

1. First, turn off and lock out the equipment's power.
2. Place the equipment and components in a safe and/or neutral position.
3. Remove access panels and inspect hose and fittings for damage or leaks.
4. Repair or replace assemblies as needed.
5. Inspect other hydraulic components.
6. Reinstall access panels.
7. Turn power back on.
8. Pay attention to unusual noises, vibrations, etc.



Hose Troubleshooting

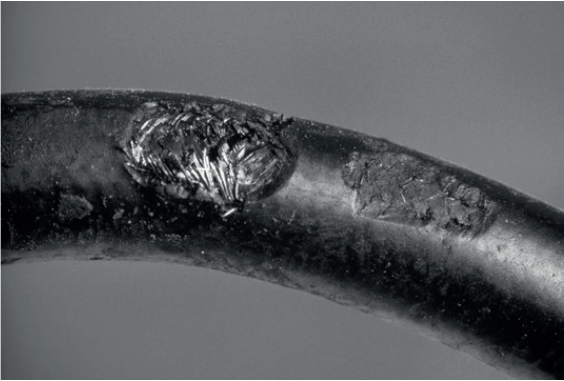

Hose Abrasion

Reroute the hose to keep it away from abrasive sources or guard the hose with a protective sleeve.



Hose Burst at Body

Inspect system operating pressure and select a hose that meets or exceeds the system's maximum pressure. Try rerouting the hose to prevent excessive flexing or keep the hose from exceeding its minimum bend radius.

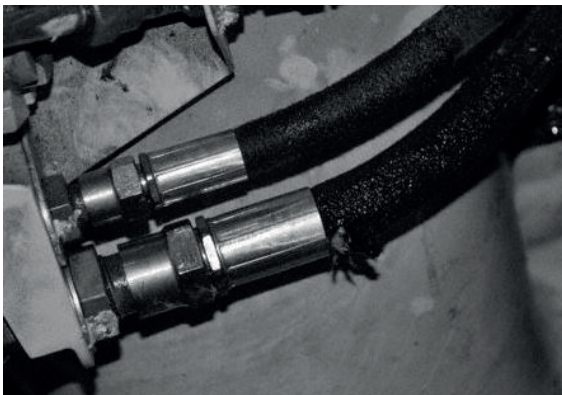

Hose Burst at Coupling

Increase the hose assembly's length to accommodate contraction under pressure; increase the hose bend radius or install bend restrictors; or replace the hose assembly with a properly crimped assembly.



Leak at Thread End/Seat

Remove the connection and inspect.

- a. Certain couplings require the use of an O-ring. If it's missing, replace it. If an O-ring is used, check for damage caused during installation or possible material breakdown from heat or fluid incompatibility. Alternative O-ring materials may be required. Replace if necessary.
- b. Check the threads and/or seat angles on both mating surfaces for damage that may have occurred prior to or during installation. Any ding or burr may be a potential leak path. Replace if necessary.
- c. If the coupling was misaligned during installation, threads may have been damaged. Replace and carefully install.
- d. Over-torquing of a threaded connection can damage threads and mating seat angles. Over-torquing can also damage the staking area of the nut, causing cracking of either the nut or seat. Under-torquing does not allow proper sealing. Use of a torque wrench can alleviate such problems.



Hose Twist

Replace and reroute the hose to ensure that bending occurs only in one plane. The use of bent tube or block-style couplings and adapters may improve routing. Also, when installing the assembly, hold the backup hex to prevent it from turning and applying a twist.

Identifying Fitting Types

NPTF

Dryseal American Standard Taper Pipe Thread

Conformance

SAE J476

ANSI B1.20.3 NPSM ANSI B1.20.1

Technical Specifications

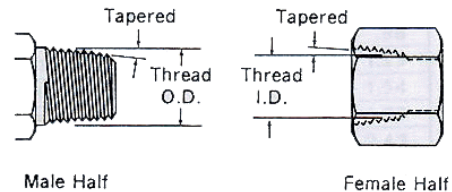

- This Type of fitting uses thread interface to seal and it has a tapered thread that deforms and forms the seal.

They have 30° sealing angle surfaces, forming a 60° concave seat.

The fittings are most frequently seen on machines of US origin.

The NPTF male will mate with the NPTF, NPSF, or NPSM females

Care should be taken not to confuse the NPTF fittings with BSPT male fitting.

NPTF fittings have a 60° thread angle,

BSPT has a 55° thread angle

A tapered thread seals by the interference in the engagement of the male and female threads. These threads deform when they are tightened, causing metal deformation and a pressure-tight joint.

Working Pressure

-Recommended working pressures are in accordance with SAE J514

Note that the fitting connection may also be affected by the following factors:

- Number of Threads Engaged
- Impulses
- Vibrations
- Thermal Expansions and Contractions

When using fittings with a different thread size or thread type, use the lower pressure rating of the two threads

Working Pressure

Dash Size	NPTF Thread Size	Workig Pressure (bar)	Workig Pressure (psi)
-2	1/8-27	345	5000
-4	1/4-18	350	5070
-6	3/8-18	280	4060
-8	1/2-14	245	3550
-12	3/4-14	210	3040
-16	1-11	175	2530
-20	1 1/4-11	145	2100
-24	1 1/2-11	145	2100
-32	2 - 11		

Dimensions and Torque installation

- Torque values are provided as a “bechmark”, believed to give optimum results for leak free connections.

Dash Size	NPTF Thread Size	Male Thread O.D. (in)	Female Thread i.D. (in)	Male Thread O.D. (mm)	Female Thread i.D. (mm)	Torque suggested (lbs.Ft)	Torque suggested (N.m)
-2	1/8-27	0.41	0.34	10.3	8.7	15	20
-4	1/4-18	0.56	0.47	14.3	11.9	22	30
-6	3/8-18	0.69	0.59	17.5	15.1	29	40
-8	1/2-14	0.84	0.72	21.4	18.3	41	55
-12	3/4-14	1.06	0.94	27	23.8	52	70
-16	1-11	1.31	1.19	33.3	30.2	66	90
-20	1 1/4-11	1.69	1.53	42.9	38.9	74	100
-24	1 1/2-11	1.91	1.75	48.4	44.5	88	120

Identifying Fitting Types

JIC 37°

Conformance
- SAE J514

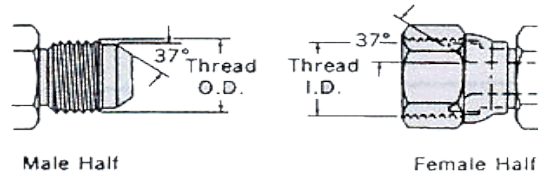

Technical Specifications

- Identification: Straight threads. Both male and female have 37° flare seat.

Application: SAE specifies use with high-pressure hydraulic hose.

A flared nut is tightened against the cone a swivel nut.

By forcing the flare against the cone during the torquing process, the nose is slightly deformed to create a metal to metal seal.

Working Pressure

- Recommended working pressures are in accordance with SAE J514

Note that the fitting connection may also be affected by the following factors:

- Number of Threads Engaged
- Impulses
- Vibrations
- Thermal Expansions and Contractions

When using fittings with a different thread size or thread type, use the lower pressure rating of the two threads.

Working Pressure

Dash Size	Tube Size	Thread	Workig Pressure (psi) Female	Workig Pressure (psi) Male	Workig Pressure (bar) Female	Workig Pressure (bar) Male
-3	3/16	3/8-24	5000	5000	344	344
-4	1/4	7/16-20	4500	5000	310	344
-5	5/16	1/2-20	4000	5000	275	344
-6	3/8	9/16-18	4000	5000	275	344
-8	1/2	3/4-16	4000	4500	275	310
-10	5/8	7/8-14	3000	3500	206	241
-12	3/4	1-1/16	3000	3500	206	241
-14	7/8	1-3/16	2500	3000	172	206
-16	1-	1-5/16-12	2500	3000	172	206
-20	1 1/4	1-5/8-12	2000	2500	138	172
-24	1 1/2	1-7/8-12	1500	2000	103	138
-32	2	2-1/2-12	1125	1500	77	103

Dimensions and Torque installation

Dash Size	JIC Thread Size	Male Thread O.D. (in)	Female Thread i.D. (in)	Male Thread O.D. (mm)	Female Thread O.D. (mm)	Torque max (lbs.Ft)	Torque max (N.m)
-3	3/8-24	0.37	0.34	9.4	8.5	8-9	11-12
-4	7/16-20	0.44	0.39	11.2	9.9	11-12	15-16
-5	1/2-20	0.49	0.45	12.6	11.5	14-15	19-21
-6	9/16-18	0.56	0.51	14.1	12.9	18-20	24-28
-8	3/4-16	0.74	0.69	18.9	17.5	36-39	49-53
-10	7/8-14	0.87	0.81	22.1	20.5	57-63	77-85
-12	1-1/16-12	1.06	0.98	26.9	24.9	79-88	107-119
-14	1-3/16-12	1.18	1.11	30.3	28.1	94-103	127-140
-16	1-5/16-12	1.31	1.23	33.1	31.3	108-113	147-154
-20	1-5/8-12	1.62	1.54	41.1	39.2	127-133	172-181
-24	1-7/8-12	1.87	1.79	47.4	45.6	158-167	215-226
-32	2-1/2-12	2.49	2.42	63.3	61.4	245-258	332-350

Identifying Fitting Types

- 1. - Place the flared part of the pipe on the body/bush cone and adjust manually.
- 2. - Tighten with the wrench so as to get a totally enclosed metal/metal joint (see table)
- 3. - A fundamental feature of the SAE 37° fitting is that it is easy and quick to assemble. It can in fact be assembled and removed on different occasions because of its enclosure which remains water and airtight at all times.

EXAMPLES

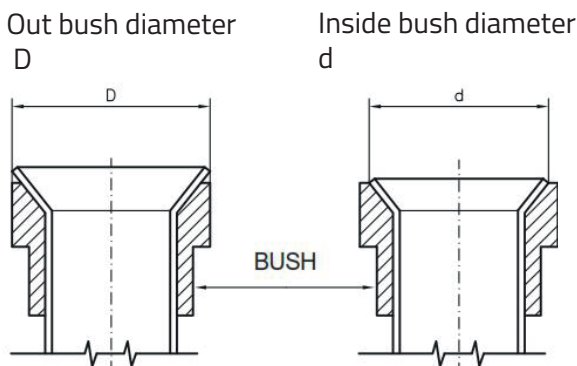

Flaring which has been done properly guarantees a longer and more satisfactory life even when subject to critical conditions over extended periods. The maximum outside flaring diameter must be the same as the outside bush diameter, while the minimum diameter must be the same as the bush's maximum inside diameter.

Technical Specifications

Tube Size	Out bush D (mm)	Inside bush d (mm)	Out bush D (in)	Inside bush d (in)
6	8	9.7	0,3150	0,3819
8	9.5	11.3	0,3740	0,4449
10	11.2	12.7	0,4409	0,5000
12	14.9	17.3	0,5866	0,6811
14	17.9	20.2	0,7047	0,7953
15	17.9	20.2	0,7047	0,7953
16	17.9	20.2	0,7047	0,7953
18	22.3	24.7	0,8780	0,9724
20	22.3	24.7	0,8780	0,9724
25	28.7	31	1,1299	1,2205
30	35.8	38.9	1,4094	1,5315
32	35.8	38.9	1,4094	1,5315
38	41.4	45.3	1,6299	1,7835

Nut Bush coupling

bush D	bush D	Nut	Code
6	1/4	7/16	DBJ04
8	5/16	1/2	DBJ05
10	3/8	9/16	DBJ06
12	1/2	3/4	DBJ08
14	-	7/8	DBJ10
15	-	7/8	DBJ10
16	5/8	7/8	DBJ10
18	3/4	1.1/16	DBJ12
20	-	1.1/16	DBJ12
25	1	1.5/16	DBJ16
30	-	1.5/8	DBJ20
32	1.1/4	1.5/8	DBJ20
38	1.1/2	1.7/8	DBJ24

Identifying Fitting Types

BSPP - BSPT

Conformance
- BS5200

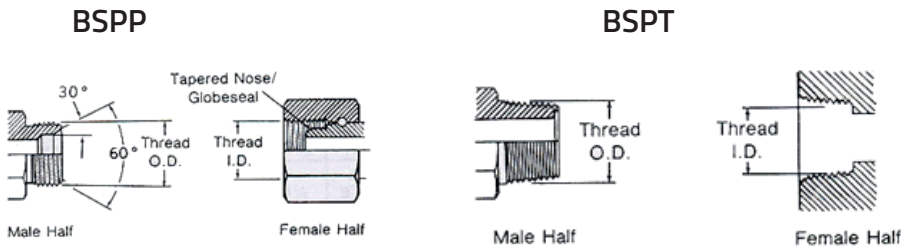

Technical Specifications

- Include two types of thread, BSPP which are straight (or parallel) and BSPT which are tapered. The BSPT tapered male will mate with a BSPT tapered female (usually a port) and seals on the thread. The BSPP parallel male has a 30° chamfered seat which seals with a BSPP female on its 30° cone seat. The BSPT fitting, although similar to the NPTF fitting, is not interchangeable. The thread pitch is different in most sizes and the thread angle is 55° for BSPT instead of the 60° found on NPTF

Function

- BSP thread are still the most widely type used today in the Fluid Power Industry in Europe. This section is split into two parts, BSPP and BSPT (tapered)

Dash Size	Thread	Workig Pressure (psi) with o-ring	Workig Pressure (bar) with o-ring	Workig Pressure (psi) without o-ring	Workig Pressure (bar) without o-rin
-2	1/8-28	-	-	5087	350
-4	1/4-19	5814	400	5087	350
-6	3/8-19	5814	400	5087	350
-8	1/2-14	5087	350	4578	315
-10	5/8-14	5087	350	4578	315
-12	3/4-14	4578	315	3634	250
-16	1-11	3634	250	2907	200
-20	1 1/4-11	2907	200	2326	160
-24	1 1/2-11	2326	160	1817	125
-32	2 - 11	1817	125	1163	80

Dimensions and Torque installation

BSPT

Dash Size	BSPT Thread Size	Male Thread O.D. (in)	Female Thread O.D. (in)	Male Thread O.D. (mm)	Female Thread O.D. (mm)
-2	1/8-28	0.37	0.33	9,5	8,4
-4	1/4-19	0.50	0.44	12,8	11,2
-6	3/8-19	0.64	0.59	16,3	14,7
-8	1/2-14	0.80	0.72	20,4	18,3
-10	5/8-14	0.89	0.81	22,5	20,6
-12	3/4-14	1.02	0.94	25,9	23,9
-16	1-11	1.28	1.17	32,6	29,7
-20	1 1/4-11	1.62	1.52	41,1	38,6
-24	1 1/2-11	1.85	1.75	47	44,5
-32	2 - 11	2.31	2.22	58,6	56,4

BSPP

Dash Size	BSPP Thread Size	Male Thread O.D. (in)	Female Thread i.D. (in)	Male Thread O.D. (mm)	Female Thread O.D. (mm)	Torque max (lbs.Ft)	Torque max (N.m)
-2	1/8-28	0.38	0.34	9,6	8,6	10	13
-4	1/4-19	0.51	0.47	13	11,9	18	25
-6	3/8-19	0.65	0.60	16,5	15,2	33	45
-8	1/2-14	0.82	0.75	20,8	19,1	46	62
-10	5/8-14	0.90	0.82	22,8	20,8	66	90
-12	3/4-14	1.04	0.97	26,3	24,6	103	140
-16	1-11	1.30	1.21	33,1	30,7	125	170
-20	1 1/4-11	1.64	1.55	41,8	39,4	206	280
-24	1 1/2-11	1.88	1.79	47,7	45,5	273	370
-32	2 - 11	2.34	2.26	59,5	57,4	369	500

Identifying Fitting Types

O-RING BOSS

Conformance

- Male fitting has a straight thread and O-ring The female port has a straight thread and a chamfer to accept the O-ring

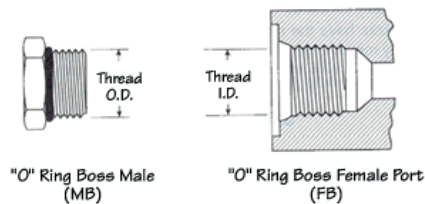

Technical Specifications

- The seal takes place by compressing the O-ring into the chamfer. The threads hold the connection mechanically. Only connect O-ring boss male with O-ring boss female

Application

- Recommended by the National Fluid Power Association for optional leakage control in medium and high-pressure hydraulic systems

Working Pressure

Dash Size	Tube Size	Thread	Workig Pres- sure (psi) nonagjustable	Workig Pres- sure (bar) nonagjustable	Workig Pres- sure (psi) agjustable	Workig Pres- sure (bar) agjustable
-3	3/16	3/8-24	9157	630	6105	420
-4	1/4	7/16-20	9157	630	6105	420
-5	5/16	1/2-20	9157	630	6105	420
-6	3/8	9/16-18	9157	630	6105	420
-8	1/2	3/4-16	9157	630	6105	420
-10	5/8	7/8-14	9157	630	6105	420
-12	3/4	1-1/16-12	6105	420	6105	420
-14	7/8	1-3/16-12	6105	420	6105	420
-16	1-	1-5/16-12	6105	420	5087	350
-20	1 1/4	1-5/8-12	4070	280	4070	280
-24	1 1/2	1-7/8-12	4070	280	3052	210
-32	2	2-1/2-12	3052	210	2544	175

Dimensions and Torque installation

Dash Size	Thread	Male Thread O.D. (in)	Female Thread i.D. (in)	Male Thread O.D. (mm)	Female Thread i.D. (mm)	Torque max (lbs.Ft)	Torque max (N.m)
-2	5/16-24	0.31	0.27	7.8	6.9	6-7	8-9
-3	3/8-24	0.37	0.34	9.4	8.5	8-9	11-12
-4	7/16-20	0.44	0.39	11.2	9.9	13-15	18-20
-5	1/2-20	0.49	0.45	12.6	11.5	17-19	23-26
-6	9/16-18	0.566	0.51	14.1	12.9	22-24	29-33
-8	3/4-16	0.74	0.69	18.9	17.5	40-43	49-53
-10	7/8-14	0.87	0.81	22.1	20.5	43-48	59-64
-12	1-1/16	1.06	0.98	26.9	24.9	68-75	93-102
-14	1-3/16	1.18	1.11	30.3	28.1	90-99	122-134
-16	1-5/16-12	1.31	1.23	33.1	31.3	112-123	151-166
-20	1-5/8-12	1.62	1.54	41.1	39.2	146-161	198-218
-24	1-7/8-12	1.87	1.79	47.4	45.6	154-170	209-231
-32	2-1/2-12	2.49	2.42	63.3	61.4	218-240	296-325

Identifying Fitting Types

DIN 2353 24° CONE

Conformance

- In accordance with DIN 2353

DIN is German Industry Standard

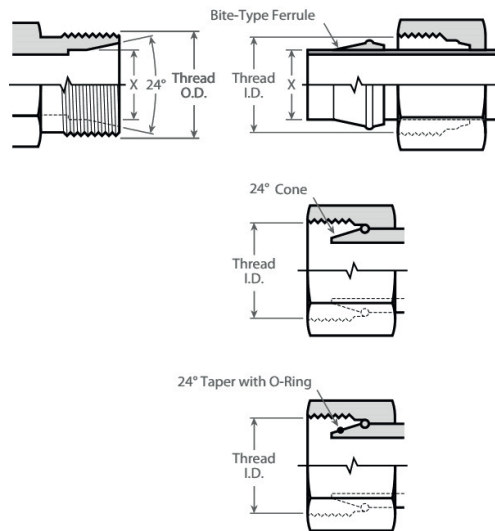

Technical Specifications

- This DIN connection comes in a Light Series (DKL/DKOL) and a Heavy Series (DKS/DKOS). Some thread sizes in each series are the same but the Tube OD of the Heavy Series is smaller and has a thicker tube wall. Light and Heavy Series are NOT interchangeable.

Seal

Sealing takes place between the 24 degree seat in the male and the respective sealing area in the female end.

Working Pressure

DIN S

Metric Tube mm	Thread	Workig Pressure (psi)
6	14x1,5	9000
8	16x1,5	9000
10	18x1,5	9000
12	20x1,5	9000
14	22x1,5	5800
16	24x1,5	5800
20	30x2	5800
25	36x2	5800
30	42x2	3600
38	52x2	3600

DIN L

Metric Tube mm	Thread	Workig Pressure (psi)
6	12x1,5	3600
8	14x1,5	3600
10	16x1,5	3600
12	18x1,5	3600
15	22x1,5	3600
18	26x1,5	2300
22	30x2	2300
28	36x2	1500
35	45x2	1500
42	52x2	1500

Dimensions Threads

Metric Thread	Female Thread		Male Thread		L Tube		S Tube	
	(mm)	(in)	(mm)	(in)	(mm)	(in)	(mm)	(in)
M 12X1.5	10.5	0.41	12	0.47	6	0.24	-	-
M 14X1.5	12.5	0.49	14	0.55	8	0.31	6	0.24
M 16X1.5	14.5	0.57	16	0.63	10	0.39	8	0.31
M 18X1.5	16.5	0.65	18	0.71	12	0.47	10	0.39
M 20X1.5	18.5	0.73	20	0.79	-	-	12	0.47
M 22X1.5	20.5	0.81	22	0.87	15	0.59	14	0.55
M 24X1.5	22.5	0.89	24	0.94	-	-	16	0.63
M 26X1.5	24.5	0.96	26	1.02	18	0.71	-	-
M 30X2	27.9	1.10	30	1.18	22	0.87	20	0.79
M 36X2	33.9	1.33	36	1.42	28	1.10	25	0.98
M 42X2	39.9	1.57	42	1.65	-	-	30	1.18
M 45X2	42.9	1.69	45	1.77	35	1.38	-	-
M 52X2	49.9	1.96	52	2.05	42	1.65	38	1.5

Identifying Fitting Types

Assembly instructions DIN 3859-2

Vitillo fittings with cutting ring include the following parts:

- 1) Union body
- 2) Double edge cutting ring
- 3) Nut

The seal between the union and the tube is obtained by tightening the nut, so that the double edge cutting ring, sliding along the bevel housing of the union will uniformly cut into the tube and, at the same time, anchors between the tube and the bevel wall

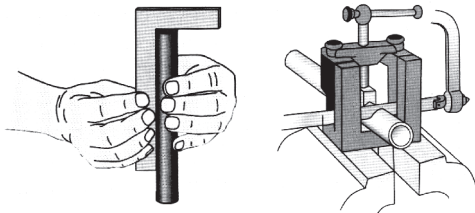
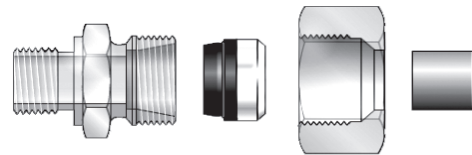

Slightly deburr the inside and outside of the pipe, without damaging the mating surface (max. bevel $0.2 \times 45^\circ$), making sure to remove all the metal particles. Lubricate with oil seat, threads and double edge cutting ring. Avoid grease.

A proper assembly of the fitting is a basic condition to obtain a good performance.

Please, follow our assembly instructions:

Rectangular saw off the pipe. An angular offset of $1/2^\circ$ is permissible. Do not use a tube cutter because this would leave a considerable burr and an angular cut at the tube ends. Use a sawing machine.

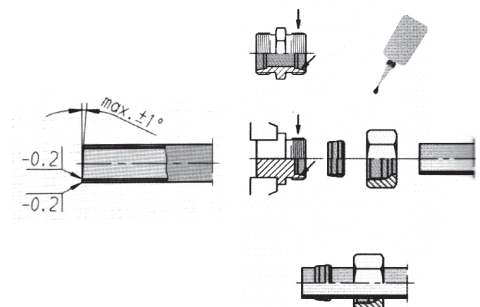

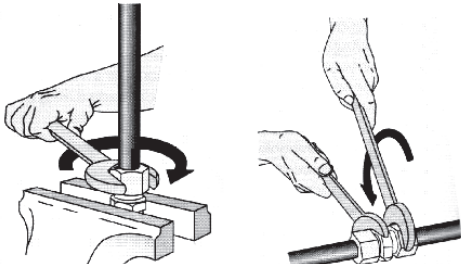

Place nut and cutting ring on the endside of the pipe.

Attention: to avoid a faulty assembly, be careful that the cutting edges of the ring face towards the tube end. Insert the pipe into the union until it reaches the stop and fully tighten the nut by hand. Tighten the nut with a spanner about 1 and 1/4 or 1 and 1/2 turns, putting reference marks on nut and tube if needed. The pipe must no longer turn within the union.

Loosen nut end inspect cut, checking the penetration of the cutting edge. The ring may rotate now. If the cut is not uniform, repeat the operation, tightening further.

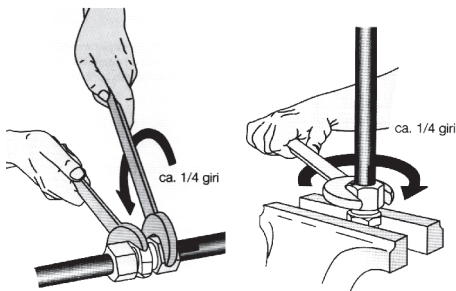
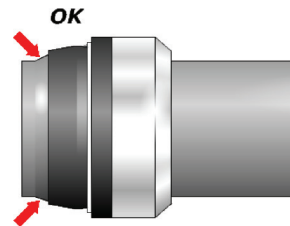

Every time the fitting is disassembled and subsequently reassembled, the nut must be re-tightened with the same force as used for the initial installation. The ends of dismantled pipes must be refitted to the same unions used for the tightening procedure.

Identifying Fitting Types

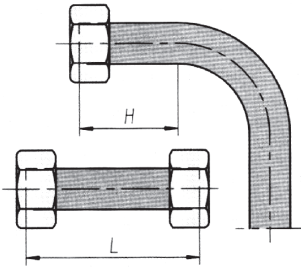

Minimum length of straight pipe in elbows: at least twice the thickness of the nut.

Minimum length of the pipe between two unions: at least 2.5-3 times the thickness of the nut.

For final assembly of all the prefitted unions, after appropriate lubrication screw the prefitted nut by hand onto the body of another union until the point of resistance is met, then tighten by a further 1/2 turn.

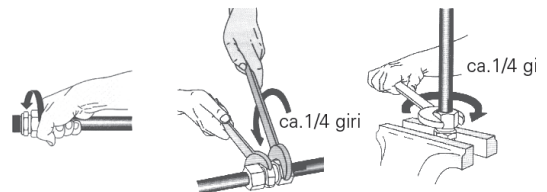

Assembly instructions – Angular rotary fitting

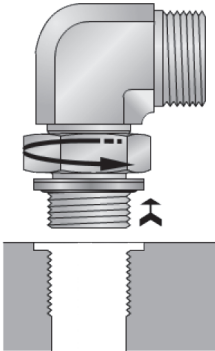

Screw back bulkhead nut as far as it goes. O-Ring and fixed anti-extrusion should be at the upper end of the notch. Oil the O-Ring. In the versions with BSPP, Metric cylindrical thread slip mobile ring over O-Ring.

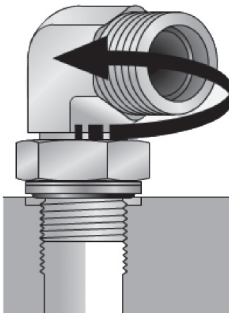

Manually screw the fitting into the threaded hole until the mobile ring or fixed anti-extrusion comes to rest. To adjust the fitting in the desired position, turn it back a maximum of one turn.

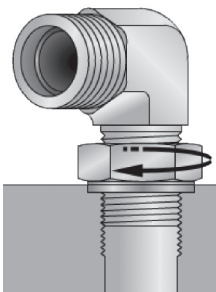

Tighten bulkhead nut completely while keeping the body in the desired position.

Identifying Fitting Types

FLANGES

SERIES L Code 61

SERIES P Code 62

CATERPILLAR

Identification:

The female port is an unthreaded hole surrounded with 4 bolt holes in a rectangular pattern. The male consists of a flanged head, grooved for an o-ring and a flange with holes to match the port.

Application:

- Commonly used in fluid power system, usually in connection with pumps and motors

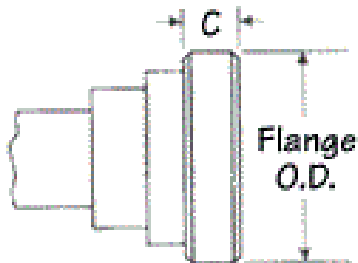

Seal

The seal takes place on the o-ring, which is compressed between the flanged head and the flat surface surrounding the port. The threaded bolts hold the connection mechanically.

Working Pressure

L Series

Nominal Flange in.	Workig Pressure (psi)
1/2	5000
3/4	5000
1	4000
1.1/4	3000
1.1/2	2700
2	2475

P Series

Nominal Flange in.	Workig Pressure (psi)
1/2	6000
3/4	5000
1	4000
1.1/4	3000
1.1/2	2700
2	2480

Dimensions

Nominal Flange in.	Flange O.D. (in) C (in)		Flange O.D. (in) C (in)		Flange O.D. (in) C (in)	
	L SERIES		P SERIES		CATERPILLAR	
1/2	1.19	0.265	1.25	0.305		
5/8	1.34	0.265				
3/4	1.50	0.265	1.63	0.345	1.63	0.56
1	1.75	0.315	1.88	0.375	1.88	0.56
1.1/4	2	0.315	2.13	0.405	2.13	0.56
1.1/2	2.38	0.315	2.5	0.495	2.5	0.56
2	2.81	0.375	3.13	0.495	3.13	0.56

Nominal Flange in.	Flange O.D. (mm) C (mm)		Flange O.D. (mm) C (mm)		Flange O.D. (mm) C (mm)	
	L SERIES		P SERIES		CATERPILLAR	
1/2	30.2	6.7	31.8	7.7		
5/8	34.0	6.7				
3/4	38.1	6.7	41.3	8.76	41.3	14.2
1	44.5	8.0	47.6	9.5	47.6	14.2
1.1/4	50.8	8.0	54	10.3	54	14.2
1.1/2	60.3	8.0	63.5	12.6	63.5	14.2
2	71.4	9.5	79.4	12.6	79.4	14.2

Identifying Fitting Types

ORFS

Conformance

- In accordance with SAE J1453

Application:

- ORFS fittings are becoming the most popular international fitting type used on global OEM machines due to their high level of sealing and their good vibration resistance. The fittings use the O-ring compression mechanism to seal. The female fittings have flat faces and straight threaded UNF swivel nuts. The male fittings have the O-ring in a groove in the flat face.

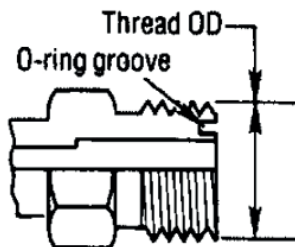

Male Flat-Face O-Ring

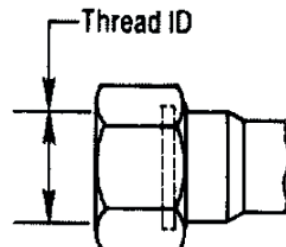

Female Flat-Face O-Ring Swivel

Technical Specifications

ORFS system consist of an ORFS male with the O-ring situated in the face, which seals against a flat seated ORFS female swivel nut fitting. The swivel nut can be slipped back to help installation in tight situations. The prominent position of the O-Ring makes it easy to inspect the condition of the O-Ring

Working Pressure

Tube Size mm	Thread ORFS	Workig Pres- sure (psi) nonagjustable	Workig Pres- sure (bar) nonagjustable	Workig Pres- sure (psi) agjustable	Workig Pres- sure (bar) agjustable
6	9/16	9157	630	5814	400
10	11/16	9157	630	5814	400
12	13/16	9157	630	5814	400
16	1	5814	400	5814	400
20	1.3/16	5814	400	5814	400
25	1.7/16	5814	400	5087	350
30	1. 11/16	3634	250	3634	250
38	2	3634	250	2907	200

Dimensions and Torque installation

Dash Size	ORFS Thread Size	Male Thread (in)	Feale Thread (in)	Male Thread (mm)	Feale Thread (mm)	Torque max (lbs.Ft)	Torque max (N.m)
-4	9/16	0.56	0.51	14.1	12.9	18	25
-6	11/16	0.68	0.63	17.3	15.9	29	40
-8	13/16	0.81	0.75	20.5	19.1	41	55
-10	1	0.99	0.93	25.2	23.6	44	60
-12	1.3/16	1.18	1.11	30.0	28.1	66	90
-16	1.7/16	1.43	1.36	36.3	34.4	92	125
-20	1. 11/16	1.68	1.61	42.7	40.8	125	170
-24	2	1.99	1.92	50.6	48.7	147	200

Identifying Fitting Types

Assembly Instructions

The proper assembly of the fitting requires several steps, each important in guaranteeing a leak-free connection and a long service life:

1. Cutting, deburring and cleaning the tube
2. Flanging or Brazing
3. Sleeve attachment
4. Inspection of sleeve attachment
5. Final installation

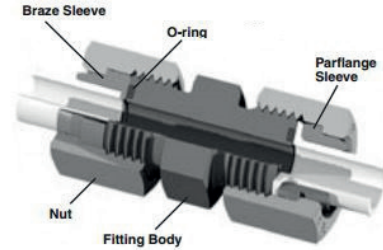

The flanging method requires the use of an appropriate forming machine to create the flange or flat face on the tube end.

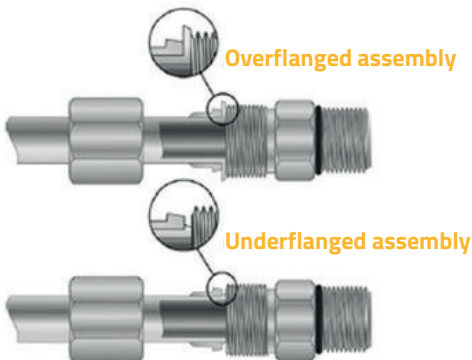
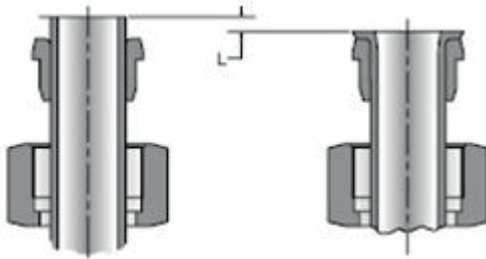

Nut Bush coupling

bush D	bush D	Bush CODE	NUT Code
6	1/4	AB006	DB006
8	5/16	AB008	DB009
10	3/8	AB010	DB009
12	1/2	AB012	DB011
14	-	AB014	DB013
15	-	AB015	DB013
16	5/8	AB016	DB013
18		AB018	DB014
20	3/4	AB020	DB014
22	7/8	AB022	DB015
25	1	AB025	DB015
28		AB028	DB021
30	1.1/4	AB030	DB021
32		AB032	DB021
35		AB035	DB032
38	1.1/2	AB038	DB032

Identification Fitting Types Chart

mm.	Male O.D.	Female I.D.	mm.	Male O.D.	Female I.D.	mm.	Male O.D.	Female I.D.
8,5	-	3/8"-24 UNF	19,2	-	1/2"-14 NPSM	33,2	1"-11 GAS	-
8,7	-	1/8"-28 GAS	20	M20x1,5	-	33,3	1.5/16"-12 UN	-
9,2	-	1/8"-27 NPSM	20,3	-	7/8"-14 UNF	33,8	1"-11,5 NPTF	-
9,4	3/8"-24 UNF	-	20,5	13/16"-16 UN	M22x1,5	34	-	M36x2
9,6	1/8"-28 GAS	-	20,8	1/2"-14 GAS	-	36	M36x2	-
10	M10x1	7/16"-20 UNF	21,1	-	5/8"-14 GAS	39,1	-	1.5/8"-12 UN
10,4	1/8"-27 NPTF	-	21,6	1/2"-14 NPTF	-	39,4	-	1.1/4"-11,5 NPSM
10,5	-	M12x1,5	22	M22x1,5	-	39,5	-	1.1/4"-11 GAS
11	7/16"-20 UNF	-	22,2	7/8"-14 UNF	-	40	-	M42x2
11,4	-	1/2"-20 UNF	22,5	-	M24x1,5	41,1	1.5/8"-12 UN	-
11,6	-	1/4"-19 GAS	22,8	5/8"-14 GAS	-	41,7	1.1/4"-11 GAS	-
12	M12x1,5	-	23,8	-	1"-14 UNS	42	M42x2	-
12,2	-	1/4"-18 NPSM	24	M24x1,5	-	42,4	1.1/4"-11,5 NPTF	-
12,5	1/2"-20 UNF	M14x1,5	24,5	-	M26x1,5	43	-	M45x2
13	1/4"-19 GAS	9/16"-18 UNF	24,6	-	3/4"-14 GAS-NPSM	45	M45x2	-
13,9	1/4"-18 NPTF	-	24,9	-	a1.1/16"-12 UN	45,2	-	1.1/2"-11 GAS
14	M14x1,5	-	25	-	M27x2	45,5	-	1.1/2"-11,5 NPSM
14,2	9/16"-18 UNF	-	25,3	1"-14 UNS	-	45,7	-	1.7/8"-12 UN
14,5	-	M16x1,5	26	M26x1,5	-	46	-	M48x2
14,6	-	5/8"-18 UNF	26,3	3/4"-14 GAS	-	47,5	1.7/8"-12 UN	-
15,1	-	3/8"-19 GAS	26,7	1.1/16"-12 UN	-	47,7	1.1/2"-11 GAS	-
15,5	-	3/8"-18 NPSM	26,9	3/4"-14 NPTF	-	48	M48x2	-
15,7	5/8"-18 UNF	-	27	M27x2	-	48,5	1.1/2"-11,5 NPTF	-
16	M16x1,5	11/16"-16 UN	27,9	-	1.3/16"-12 UN	48,8	-	2"-12 UN
16,5	-	M18x1,5	28	-	M30x2	50	-	M52x2
16,6	3/8"-19 GAS	-	30	M30x2	-	50,7	2"-12 UN	-
17,3	3/8"-18 NPTF	-	30,1	1.3/16"-12 UN	-	52	M52x2	-
17,4	11/16"-16 UN	3/4"-16 UNF	30,7	-	1"-11,5 NPSM	57	-	2"-11 GAS
18	M18x1,5	-	30,9	-	1"-11 GAS	59,4	2"-11 GAS	-
18,5	-	M20x1,5	31	-	M33x2	60,6	2"-11,5 NPTF	-
18,8	-	1/2"-14 GAS	31,2	-	1.5/16"-12 UN	61,2	-	2.1/2"-12 UN
19	3/4"-16 UNF	13/16"-16 UN	33	M33x2	-	63,3	2.1/2"-12 UN	-

O-RING

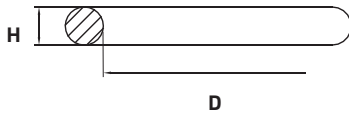

DIN 2353 24° CONE

Size	D	H	D	H
	mm	mm	in	in
6L/S	4	1,5	0,157	0,059
8L/S	6	1,5	0,236	0,059
10L/S	7,5	1,5	0,295	0,059
12/L/S	9	1,5	0,354	0,059
14S	10	2	0,394	0,079
15L/S	12	2	0,472	0,079
18L	15	2	0,591	0,079
20S	16,3	2,4	0,642	0,094
22L	20	2	0,787	0,079
25S	20,3	2,4	0,799	0,094
30S	25,3	2,4	0,996	0,094
28L	26	2	1,024	0,079
35L	32	2,5	1,260	0,098
38S	33,3	2,4	1,311	0,094
42L	38	2,5	1,496	0,098

ORFS - ISO 8434-3

Size	D mm	H mm	D in	H in
6	7,65	1,78	0,301	0,070
8-10	9,25	1,78	0,364	0,070
12	12,42	1,78	0,489	0,070
14-15-16	15,6	1,78	0,614	0,070
18-20	18,77	1,78	0,739	0,070
22-25	23,52	1,78	0,926	0,070
28-30-32	29,87	1,78	1,176	0,070
35-38	37,82	1,78	1,489	0,070

BSPP - ISO 1179-3

Size	D mm	H mm	D in	H in
G 1/8"	7,97	1,88	0,314	0,074
G 1/4"	10,77	2,62	0,424	0,103
G 3/8"	13,94	2,62	0,549	0,103
G 1/2"	17,86	2,62	0,703	0,103
G 3/4"	23,47	2,62	0,924	0,103
G 1"	29,74	3,53	1,171	0,139
G 1,1/4"	37,69	3,53	1,484	0,139
G 1,1/2"	44,04	3,53	1,734	0,139
G 2	55,56	3,53	2,187	0,139

O-RING

METRIC - ISO 6149-2-3

Size	D mm	H mm	D in	H in
M 10X1	8,1	1,6	0,319	0,063
M 12X1,5	9,3	2,2	0,366	0,087
M 14X1,5	11,3	2,2	0,445	0,087
M 16X1,5	13,3	2,2	0,524	0,087
M18X1,5	15,3	2,2	0,602	0,087
M 20X1,5	17,3	2,2	0,681	0,087
M 22X1,5	19,3	2,2	0,760	0,087
M 27X2	23,6	2,9	0,929	0,114
M 33X2	29,6	2,9	1,165	0,114
M 42X2	38,6	2,9	1,520	0,114
M 48X2	44,6	2,9	1,756	0,114

UNF/UN THREAD - ISO 11926-2-3

Size	D mm	H mm	D in	H in
7/16-20	8,92	1,83	0,351	0,072
1/2-20	10,52	1,83	0,414	0,072
9/16-18	11,9	1,98	0,469	0,078
3/4-16	16,36	2,2	0,644	0,087
7/8-14	19,18	2,46	0,755	0,097
1,1/16-12	23,47	2,95	0,924	0,116
1,5/16-12	29,74	2,95	1,171	0,116
1,5/8-12	37,46	3	1,475	0,118
1,7,8-12	43,69	3	1,720	0,118

FLANGE

SERIES L code 61

SERIES P code 62

CATERPILLAR

Size	D mm	H mm	D in	H in
1/2	18,64	3,53	0,734	0,139
3/4	24,99	3,53	0,984	0,139
1	32,92	3,53	1,296	0,139
1,1/4	37,69	3,53	1,484	0,139
1,1/2	47,22	3,53	1,859	0,139
2	56,74	3,53	2,234	0,139

Technical handbook a-2015

Data reported in this catalogue are not binding.
Vitillo S.p.a. reserves the right to change specifications without notice.

I dati riportati nella seguente pubblicazione non sono vincolanti.
Vitillo S.p.a. si riserva di apportare modifiche senza preavviso.

Les données exposées dans ce catalogue ne sont pas contraignantes.
Vitillo s.p.a. se réserve le droit d'apporter des modifications sans aucun préavis.

Die vorliegenden Angaben sind nicht bindend.
Vitillo S.p.a. behält sich technische Änderungen vor ohne Mitteilung.

Los datos referidos en la presente publicación son indicativos.
Vitillo S.p.a. se reserva el derecho de modificar las especificaciones sin aviso previo.



Vitillo SPA

Zona Pip Camporeale
83031 Ariano Irpino (Av)
Italy
+39 0825 881555
+39 0825 881956

Vitillo USA llc

76 Blackburn Center
01930 Gloucester MA
Massachusetts
978-283-0601
978-283-0602

Vitillo Germany GmbH

Düsselberger Str.19
D-42781 Haan
Germany
+49 2104-17420-0
+49 2104-17420-39

Vitillo Poland

Ul. Dworcowa, 53
44340 Laziska-Godow
Poland
+48 327203540
+48 327203541



vitillo.eu
info@vitillo.eu

a – 2015